

SEAT and BACK CUSHIONS

plain



or

quilted

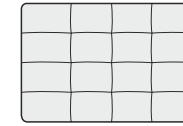

EXAMPLE quilted

2 SEATER with metal legs no.170

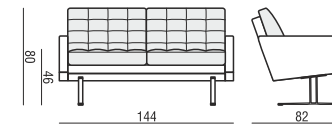

ARMRESTS

wood fabric

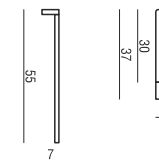

EXAMPLE

ARMCHAIR with WOOD ARMRESTS

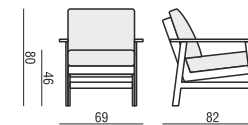

ELEMENT 55 + 2x ARMRESTS

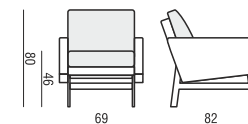

ELEMENT 65 LEFT (or RIHGT)

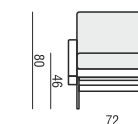

ELEMENT 65 without ARMRESTS

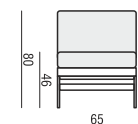

2 SEATER

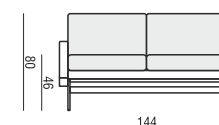

2 SEATER LEFT (or RIGHT)

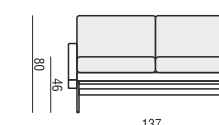

2 SEATER without ARMRESTS

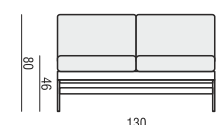

CORNER 90°

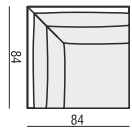

FOOTSTOOL 45x55

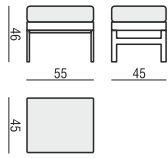

FOOTSTOOL 45x65

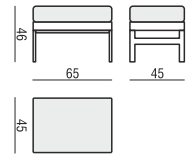

SET 1 LEFT (or RIGHT)
ELEMENT 65 LEFT (or RIGHT) + CORNER 90°
+ 2 SEATER RIGHT (or LEFT)

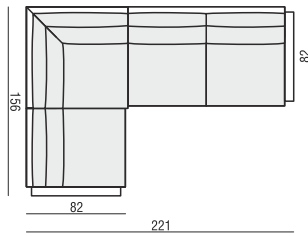

SET 2
2 SEATER LEFT + CORNER 90°
+ 2 SEATER RIGHT

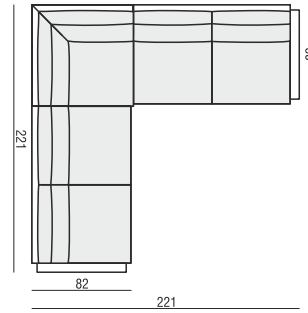

UPHOLSTERY **FABRIC and LEATHER: FC - fix cover**

FEET **for fabric or wood armrests
wooden legs**

- no. 167A - element 55 no. 167C - 2 seater no. 167E - footstool 45x55
- no. 167B - element 65 no. 167D - corner 90° no. 167F - footstool 45x65

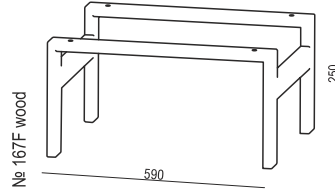
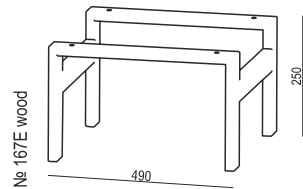
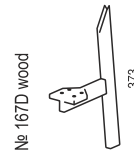
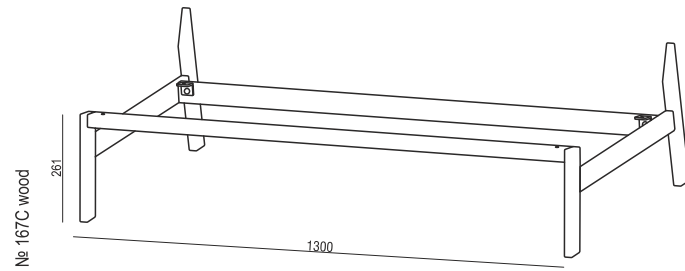
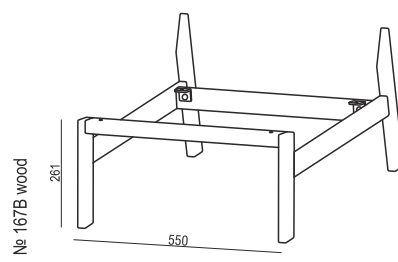
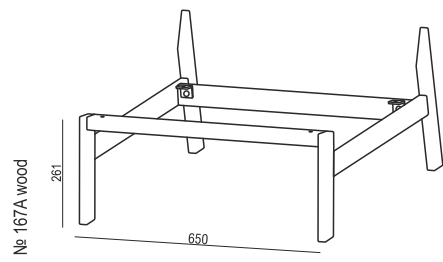

FEET

**only for fabric armrests
metal legs**

- no. 168 - elements and sofas no. 169 - elements and sofas no. 170 - elements and sofas
- no. 168A - corner 90° no. 169A - corner 90° no. 168A - corner 90°
- no. 168B - footstool no. 169B - footstool no. 170B - footstool

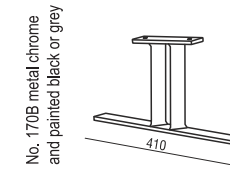
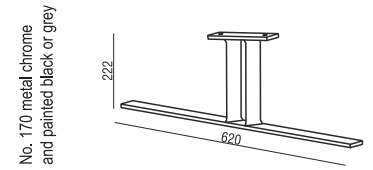
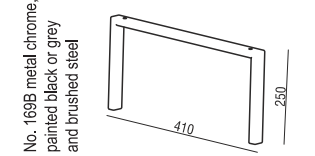
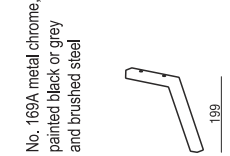
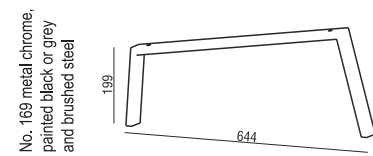
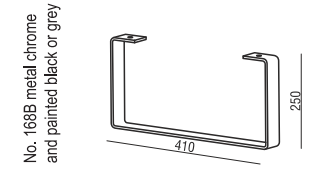
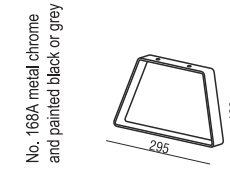
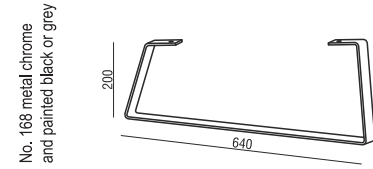

STANDARD COMFORT plain

1. polyurethane foam/high resilient polyurethane foam
2. upholstery belts
3. FSC® certified solid wood and wood based elements
4. fabric or leather
5. FSC certified solid wood or metal legs

STANDARD COMFORT quilted

1. polyurethane foam/high resilient polyurethane foam
2. upholstery belts
3. FSC® certified solid wood and wood based elements
4. fabric or leather
5. FSC certified solid wood or metal legs